

MORE THAN STANDARD

HALSANG



FACTORY • LOGISTICS
INFRASTRUCTURE • TRANSPORT
PUBLIC SPACES • BUILDINGS

TURNSTILES

ACCESS CONTROL

TURNSTILE HHT3/HHT4 FULLY AUTOMATIC

Turnstile used for pedestrian access control.

ADVANTAGES

FAST AND SAFE

The turnstiles are designed for continuous operation and can be successfully used in areas with High frequency passages. Suitable areas: factories, commercial buildings, harbours etc.

The turnstile has a rotating spindle with 3 (120 degree) or 4 arms (90 degree), depending on requested security level.

MODE OF OPERATION

The two-way mechanism enables traffic control in both directions or in a selected direction.

The LED pictograms (red cross & green arrow), easily visible and situated on the cabinet indicate the status of the turnstile (locked/unlocked). The red cross indicates passage closure, the green arrow indicates passage opening. The turnstile mechanism allows smooth entrance/exit and is equipped with a mechanical, as well as a magnetic lock for optimal security. The spindle is motorised, ensuring smooth entrance/exit for the user.

HHT3



HHT4



TURNSTILE • FULLY AUTOMATIC HHT3/HHT4

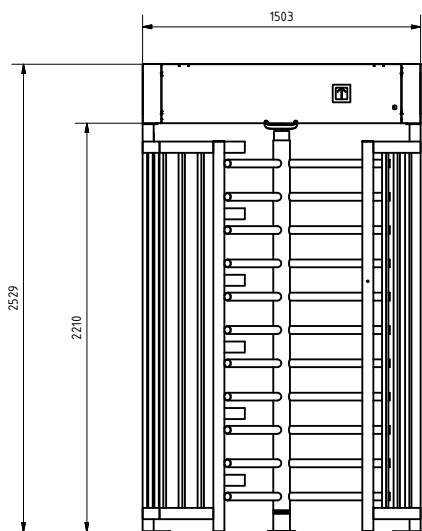

HHT3

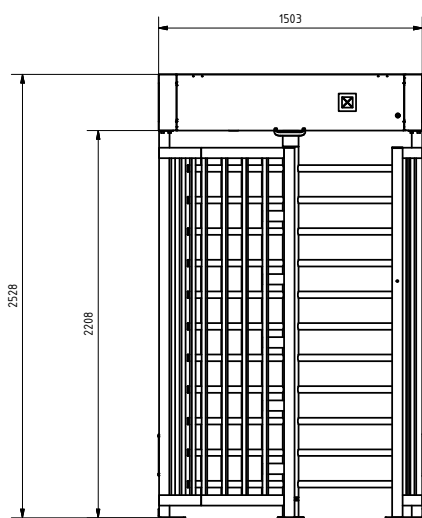
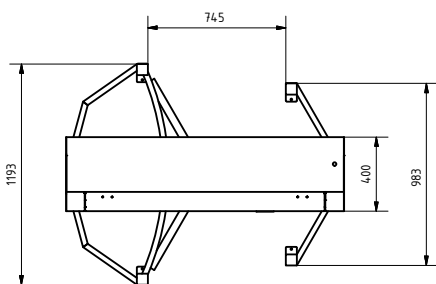

HHT4

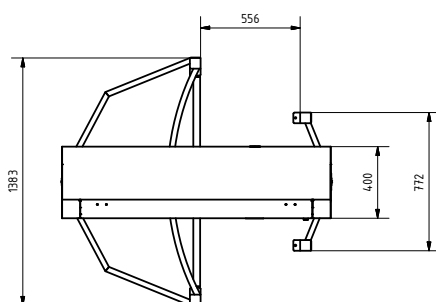

FEATURES

- Turnstile mechanism is made of high quality steel and equipped with high quality bearings. Brake/locking system has a very short response time (from 0.03 to 0.12s). In the event of a power failure, the mechanism will be automatically unlocked to allow safe exit from the building and will prevent entry.
- The control (H104) has a wide range of options allowing various individual requirements
- Easy access for service and maintenance in the cabinet
- Illumination of passage as standard (controlled by a light sensor)
- Pictogram (red/green) as standard on both sides of the cabinet
- Prepared for external card reader
- Stainless steel spindle and cabinet as standard
- Cage in HDG as standard
- 15-20 passages/min

TECHNICAL DESCRIPTION

Total height	2,530 mm
	Other dimensions: on request.
Power supply voltage	230V AC, 50 Hz
Power consumption	max 120 W
Current	5A
Feedback signal	Potential free contact – no/nc
Opening signal	Signal (max. 1 sec)
Operation environment	-25° to +50° C
Weight	HHT3 240 kg, HHT4 248 kg
Relative humidity	Environmental 10-80%
IP protection rating	40
Cabinet	Stainless steel, 1.5 mm
Cage Profiles	100x50x3 mm, 60x60x2 mm, 60x30x2 mm and 25x25x1.5 mm
Spindle core tube	90x3 mm
Spindle arms	38x2 mm



Turnstile mechanism – high standard brake with short response time.



Electrical cabinet equipped with a Halsang H104 controller and frequency modulators

OPTIONS

- Overclimbing protection
- Fencing connection on post
- Roof in polycarbonate
- Powder coated cage in RAL colors.

We reserve the right to make any changes to technical specifications due to product development and/or to meet governmental requirements. © Halsängs Stängsel AB • Sweden • 2019

